

Olvasd el a ragasztási tanácsokat is!

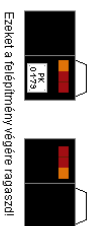

Ezeket a felítmény végére ragaszd!

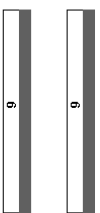
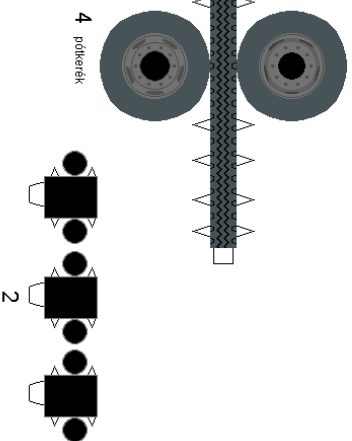

2



A vonddel a kijelölt helyre ragaszd!

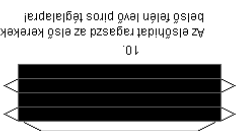

Az előlédet ragaszd az első kerekre belső felén levő piros téglalapra!



A kerekeket ragaszd a kerekek belső felén levő piros keretrel!

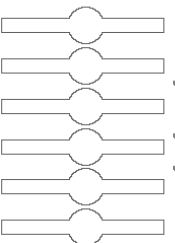

A hátsó hídát összeragaszthatod az előző sablonból is, de ha az nem érneked, tudnk, akkor ezekből 6-6-ot összeragasztasz egymással, a két végükre meg ragasztod a fekete részeket, és ugyanazt az eredményt kapod!

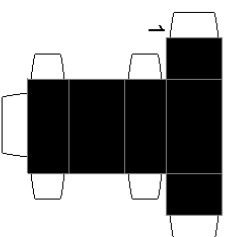
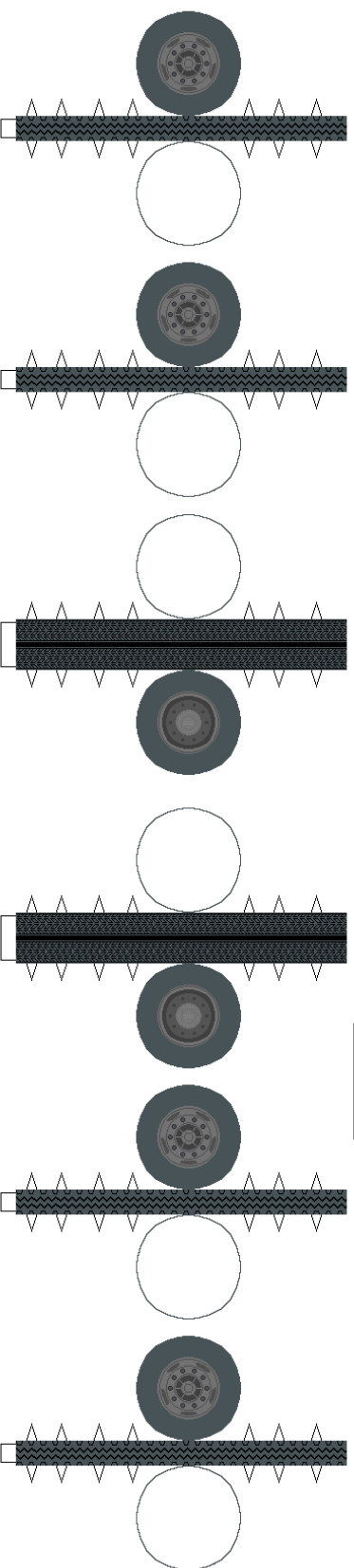
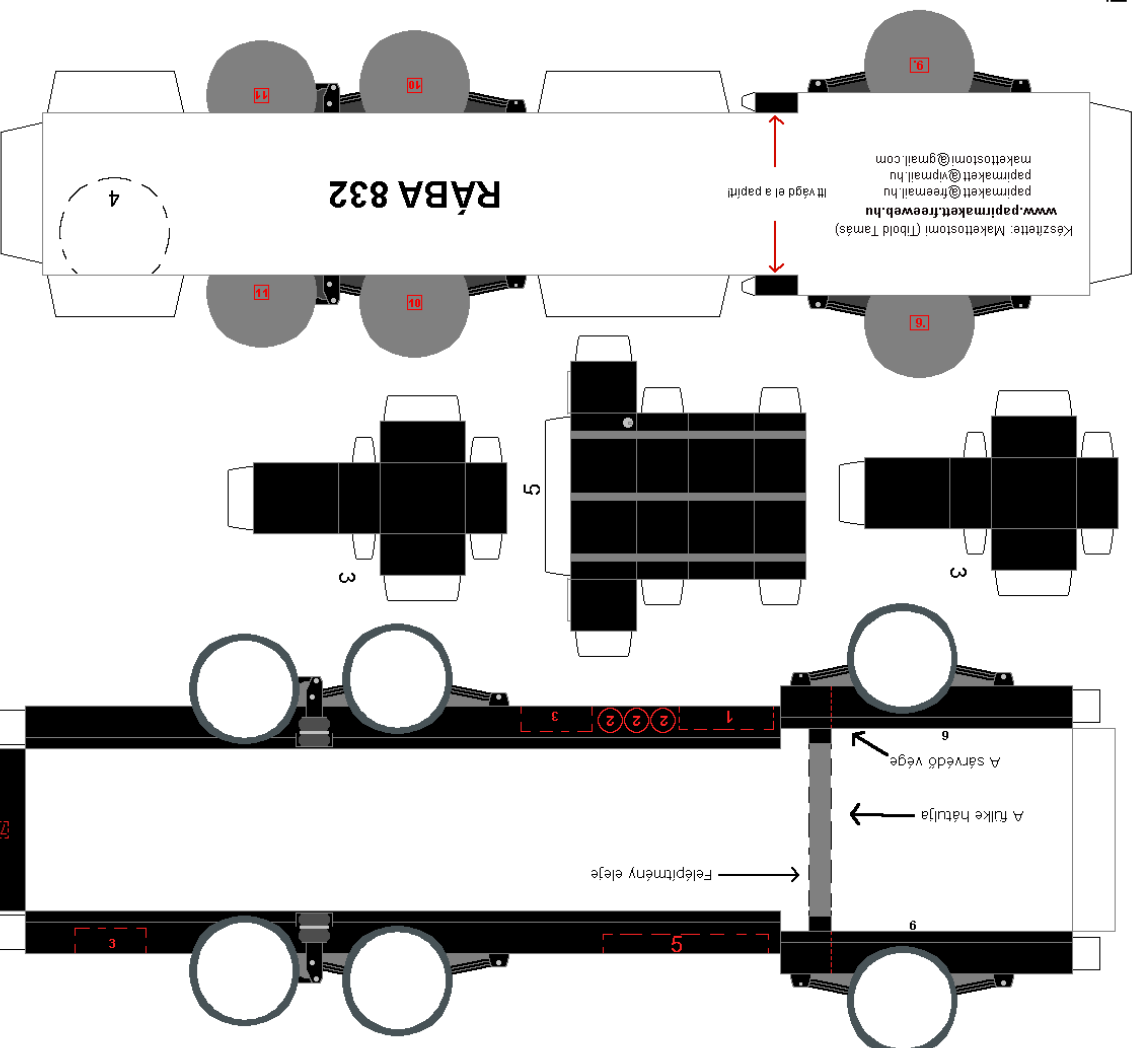
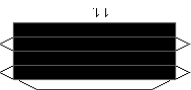

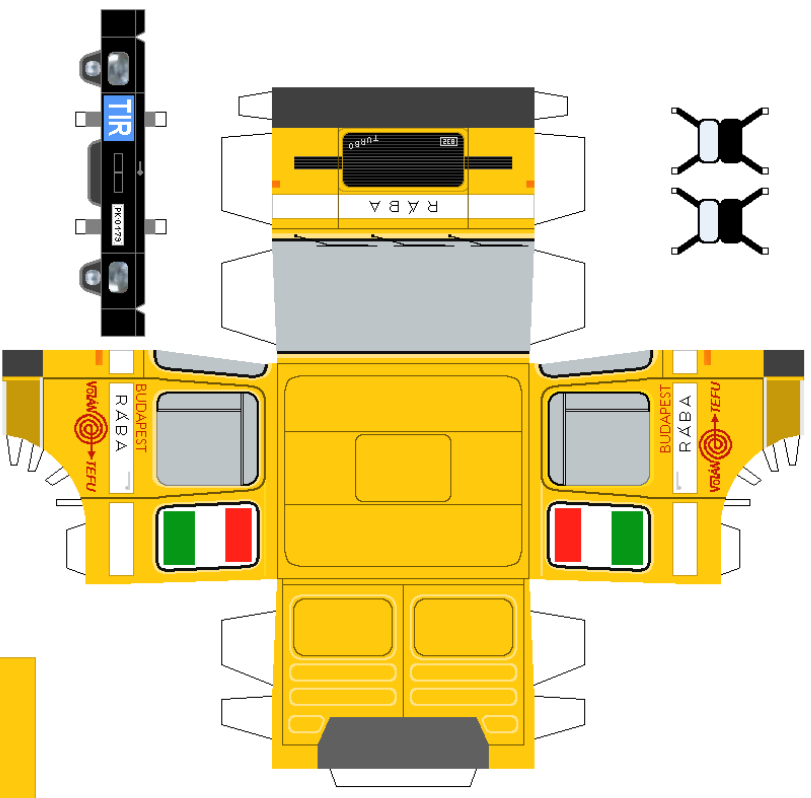
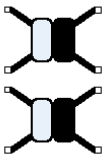

A legelőször ragaszd a Tíka felé!
A teteje csíkjait 2-2-1 ragaszd össze egymással szemben
és azzal támaszd ki hátra!

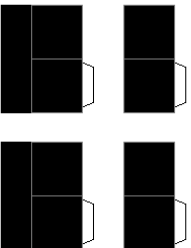
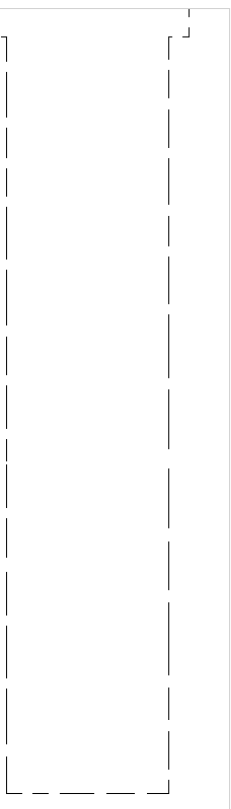
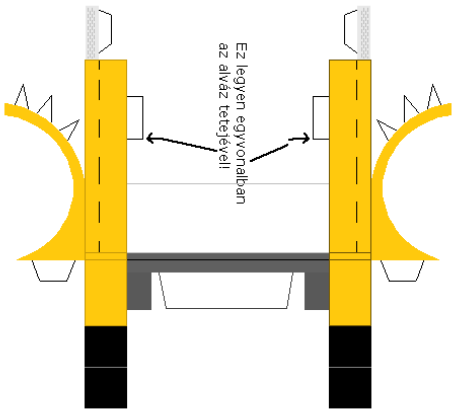

A kerekeket a hátsó kerek
elé, és előre ragaszd!

