

Olvasd el a ragasztási tanácsokat is!

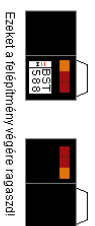

Ezeket a felítmény végére ragaszd!

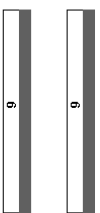
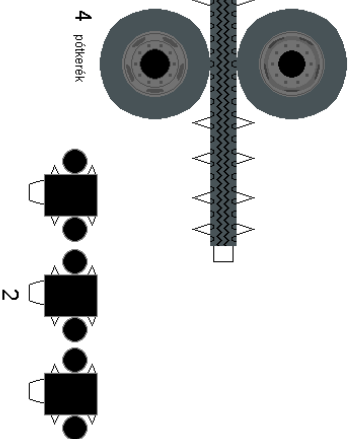

2

4 pdkerek

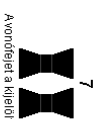

7
A vonófejt a kijelölt helyre ragaszd!

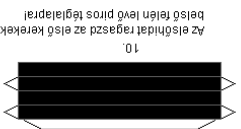

10
Az elősíntát ragaszd az első kerek
belső felére pros téglalapra!



9
A hátsóhidat ragaszd a kerekek belső felére pros kerekre!

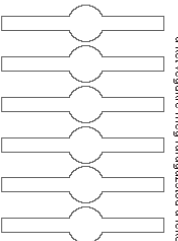

11
A hátsó hidat összeragasztand az előző sablonból is, de ha az
nehéznek tűnik, akkor ezekből 6-6-ot összeragasztasz egymással,
a két végükre meg ragasztod a felüle részeket, és ugyanazt az eredményt kapod!

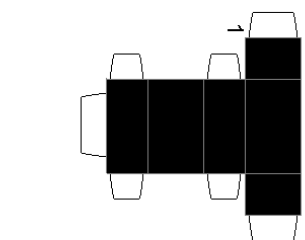
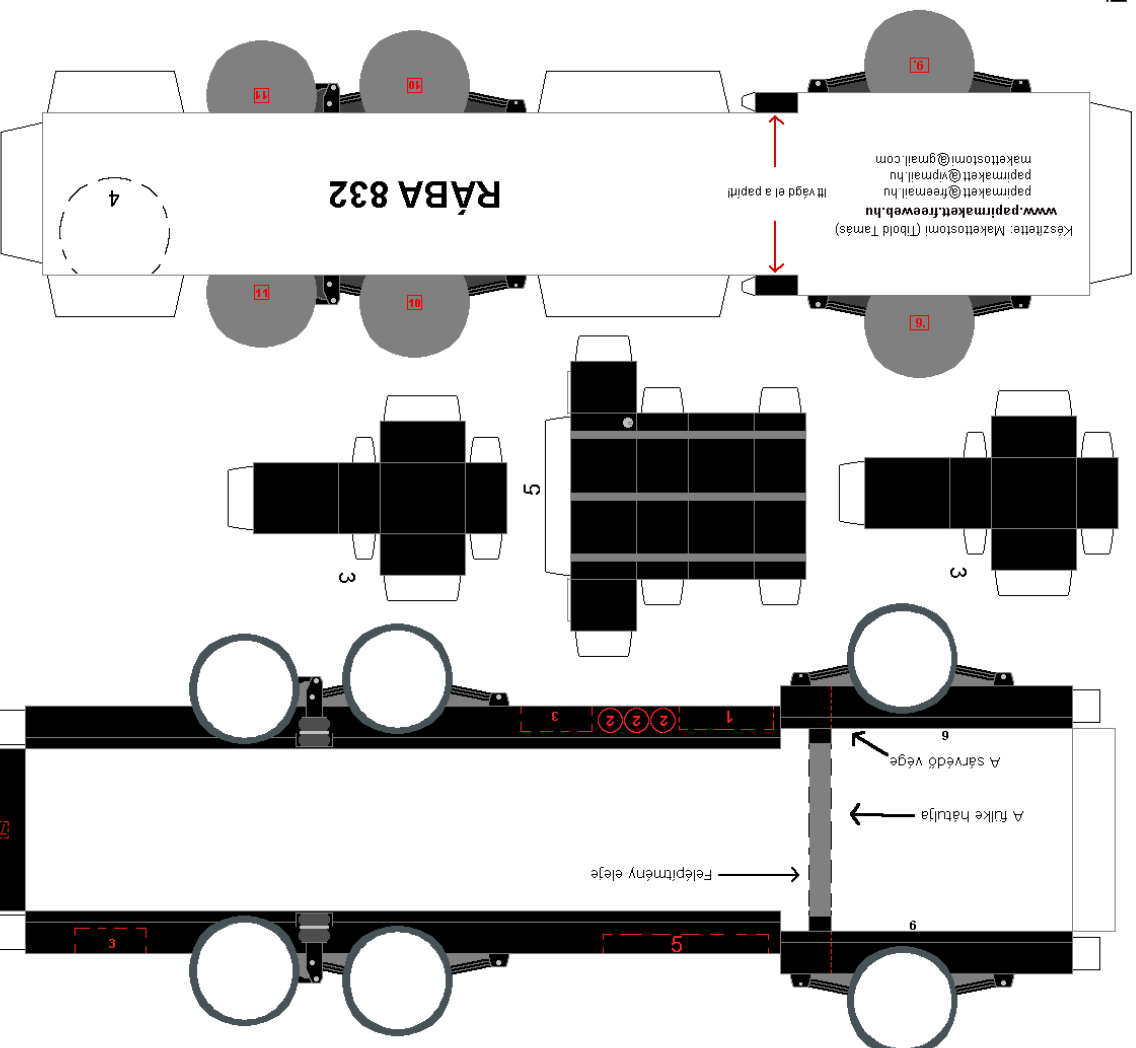
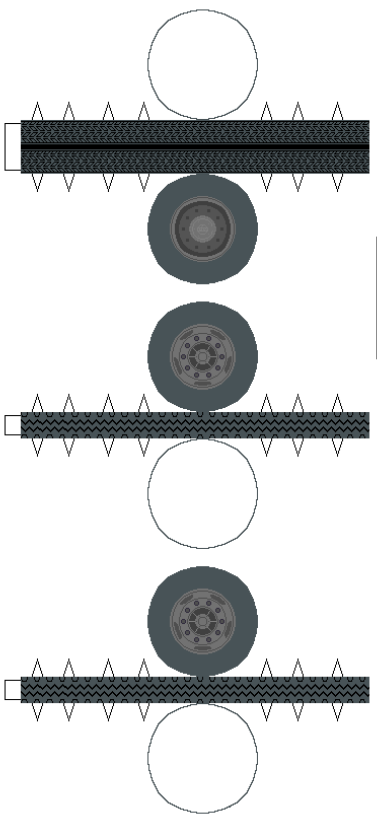
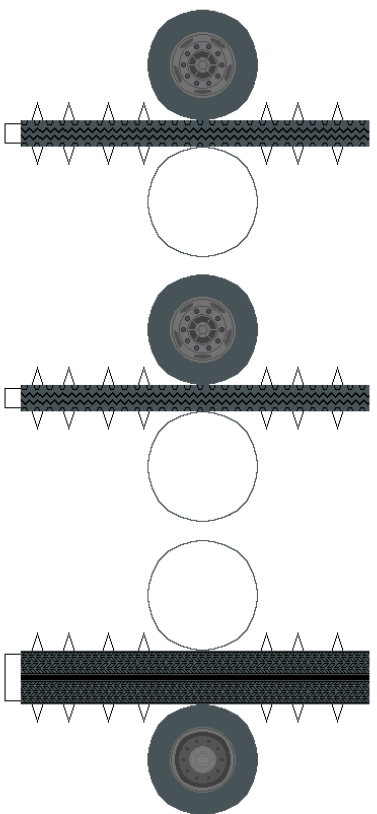

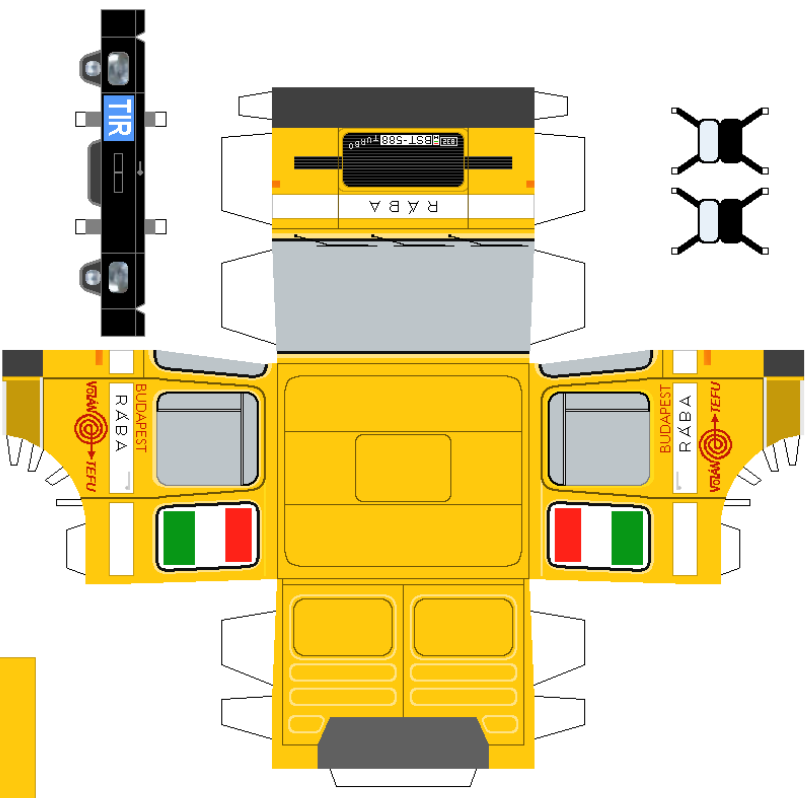
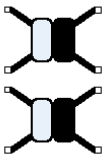

A legördült ragaszd a Tüke felé! A fekete csíkokkal 2-2-1 ragaszd össze egymással szemben és azzal támaszd ki hául!

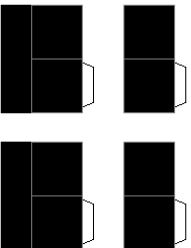
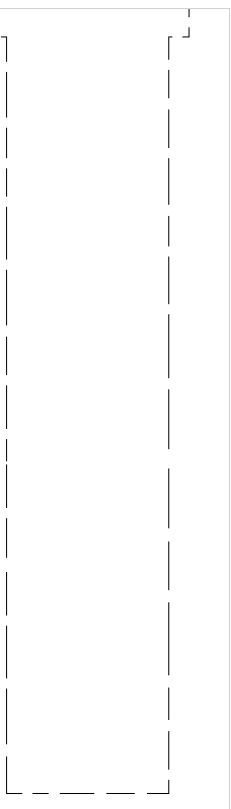
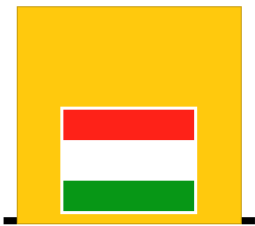

A szívettséget a hátsó kerek elre és mögött ragaszd!

