

Olvasd el a ragasztási tanácsokat is!

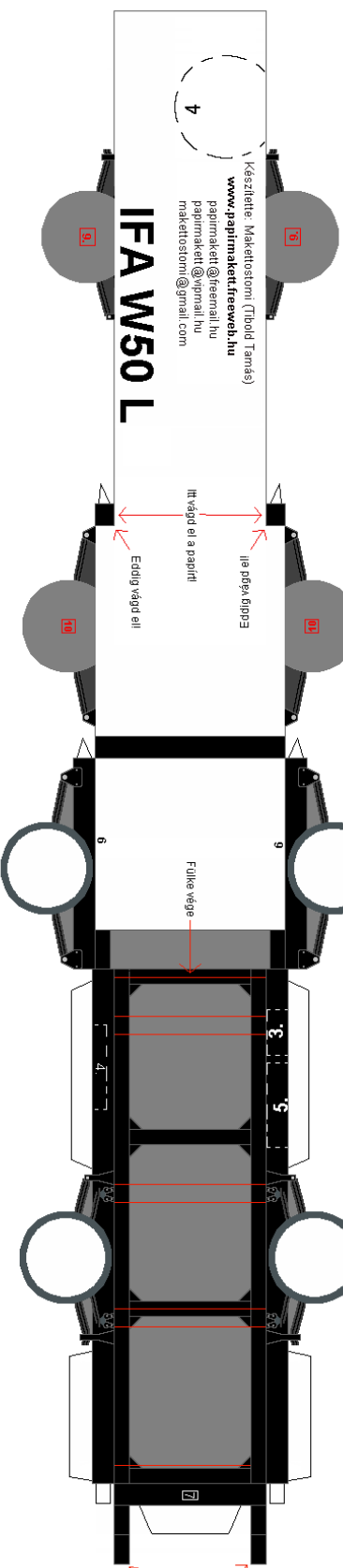

A vonalak mentén, de kell vágdosni!

A sárvédőket közepen hajtásd össze, és formázz belőlük félkört, ezután ragaszd a keretek fölé!

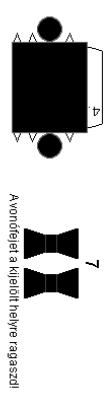
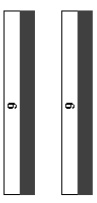
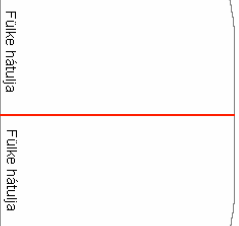
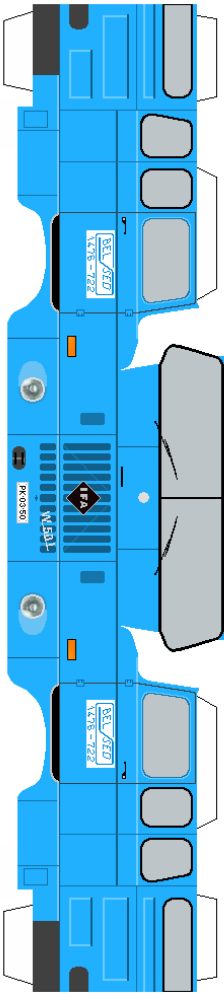
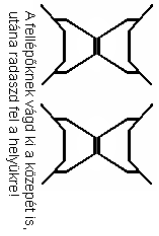
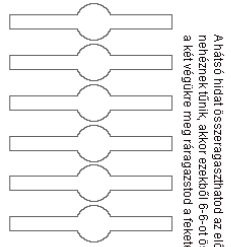
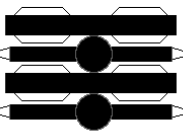
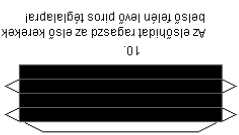
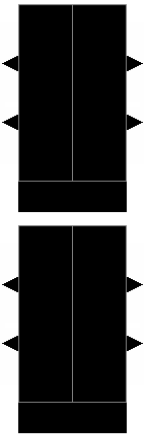
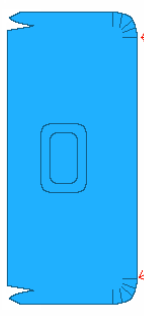

Ezt ragaszd össze, utána ragaszd köré a fülkét, így nem kell szarnod az ívek kialakításával! A fülke hátsó részét, a piros vonallal kezd el felragasztani!

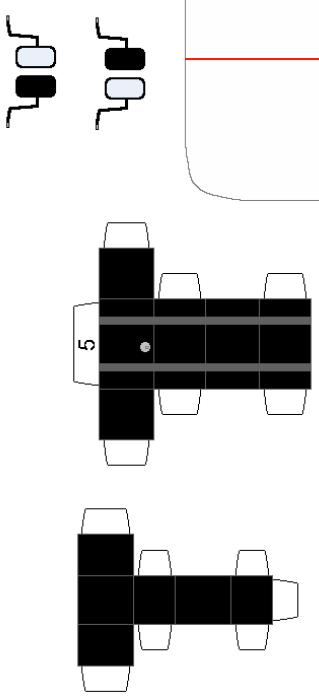
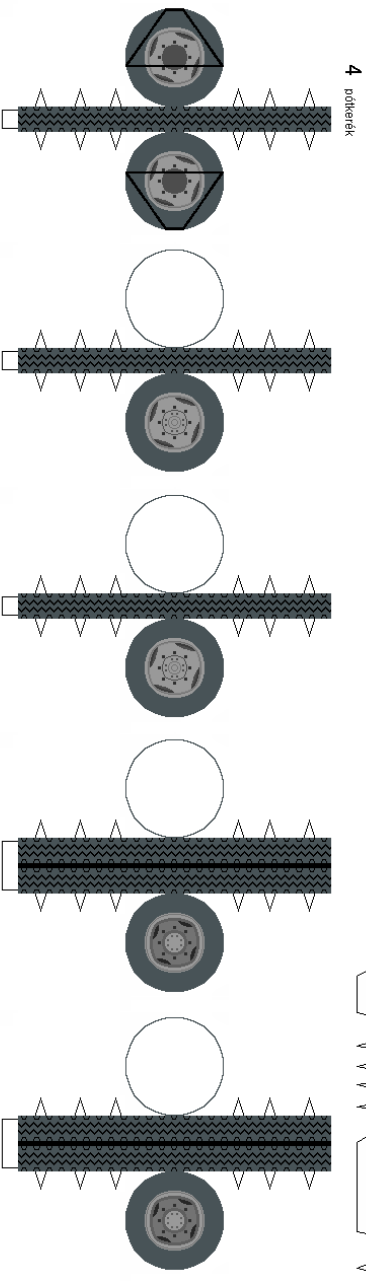

A lábdobozt ragaszd a fülke tetejére!  
A fülkét illeszd a 2.1. rajzhoz össze egymással szemben  
és szorítsd ki fűzőt!

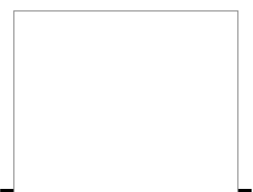

A segédvonalakat ragaszd, az alvázon található,  
piros vonalaktól!

