

Olvasd el a ragasztási tanácsokat is!

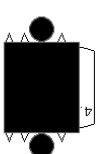

Avonofelel a kijelölt helyre ragaszd!

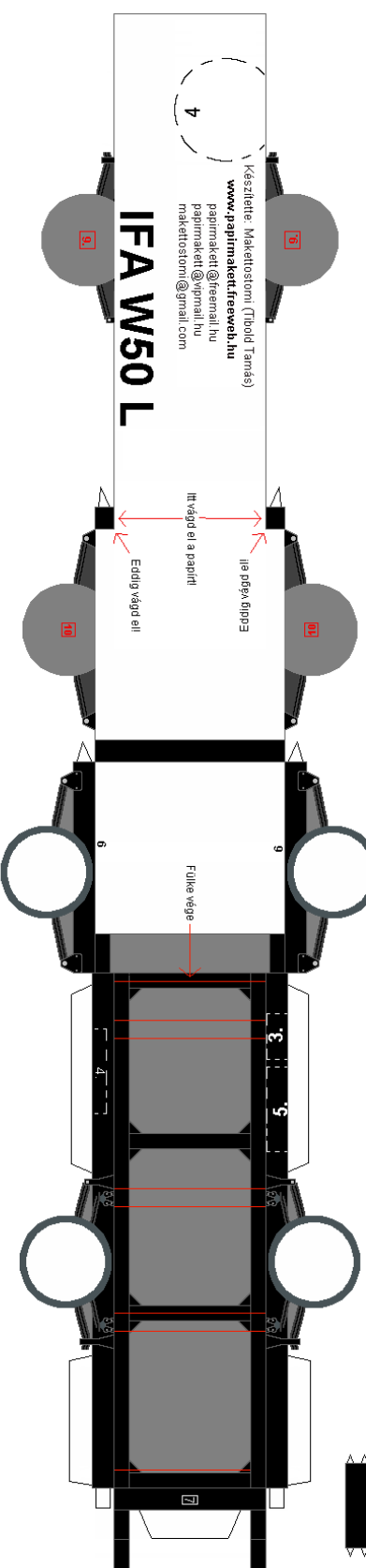

A sárvédőket közepen hajtásd össze, és formázz belőlük félkört, ezután ragaszd a keretek fölé!

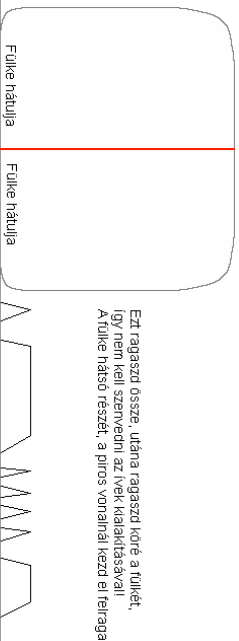
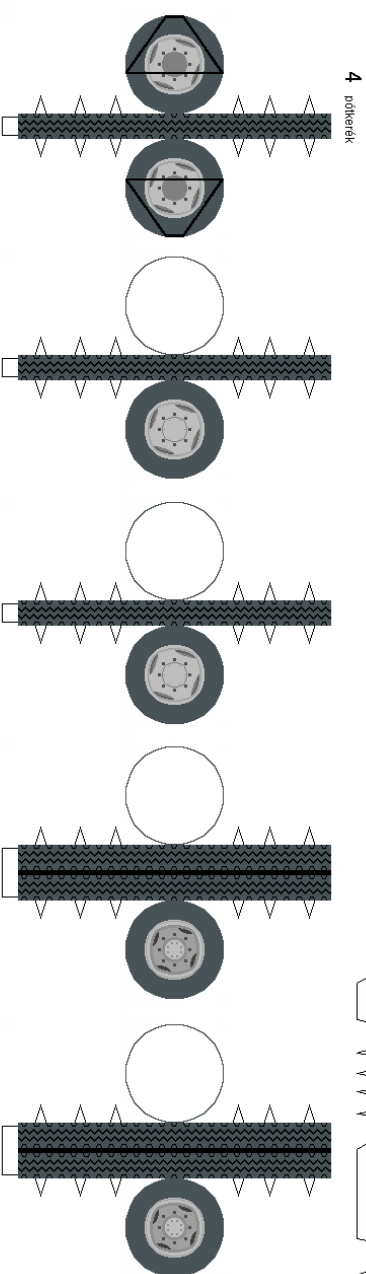
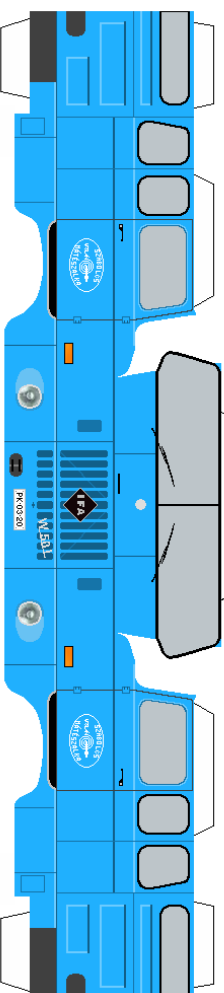
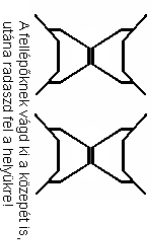
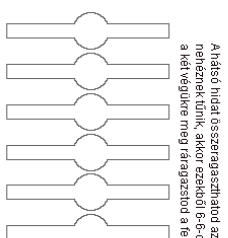
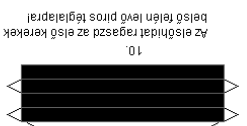
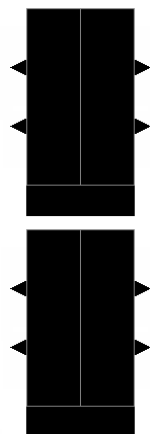
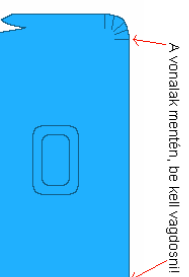

Ezt ragaszd össze, utána ragaszd köré a fülkét, így nem kell szarni az ívek kialakításával. A fülke hátsó részét, a piros vonallal kezd el felragasztani!

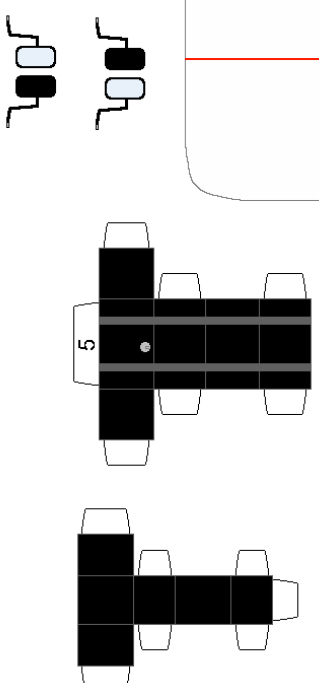

A segédvonalakat ragaszd, az alvázon található,  
piros vonalakra!

