

Olvasd el a ragasztási tanácsokat is!

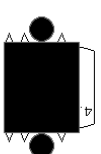

Avonofelel a kijelölt helyre ragaszd!

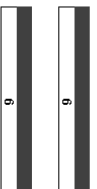
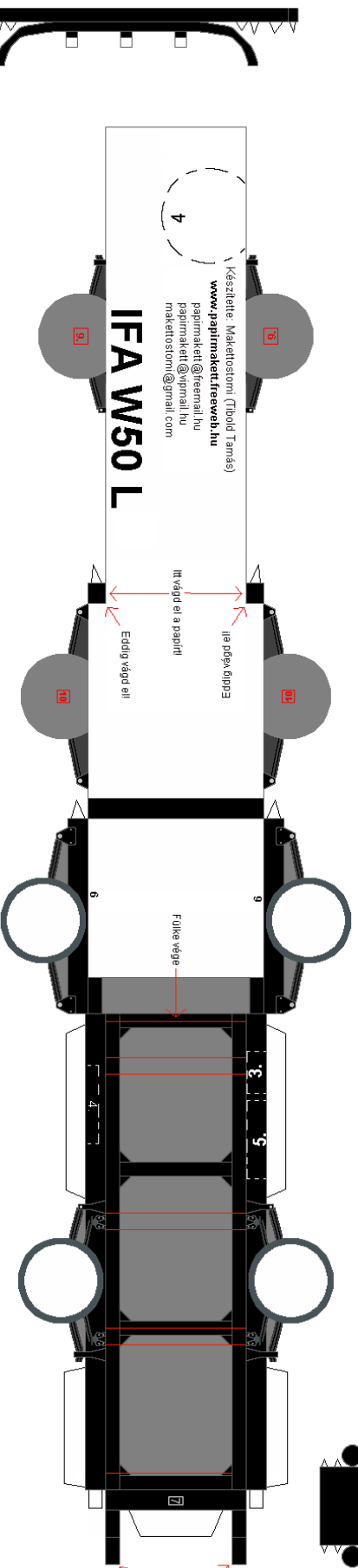

Készítette: Meketostomi (Tibold Tamás)
www.papimaketfreeweb.hu
papimaket@freemail.hu
papimaket@vipmail.hu
meketostomi@gmail.com

IFA W50 L

4

Itt párgy gíppoz
Itt vágd el a papírt!
Eddig vágd el!

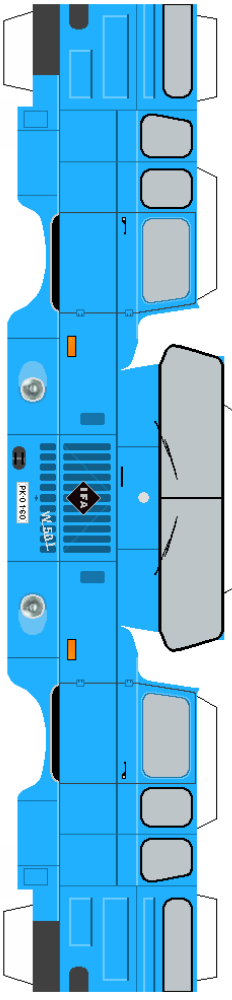
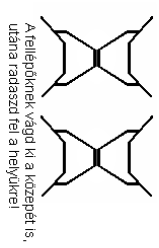
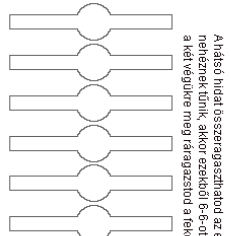
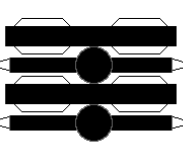
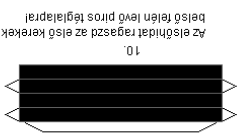
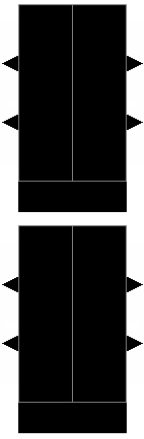
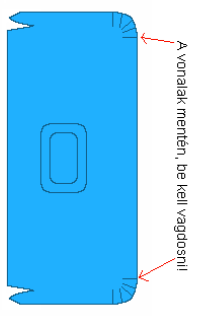

4 potkerek

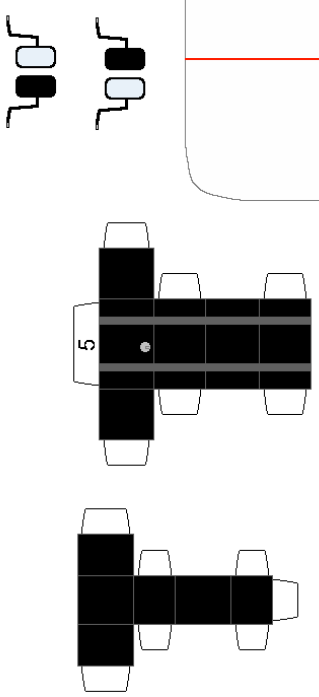
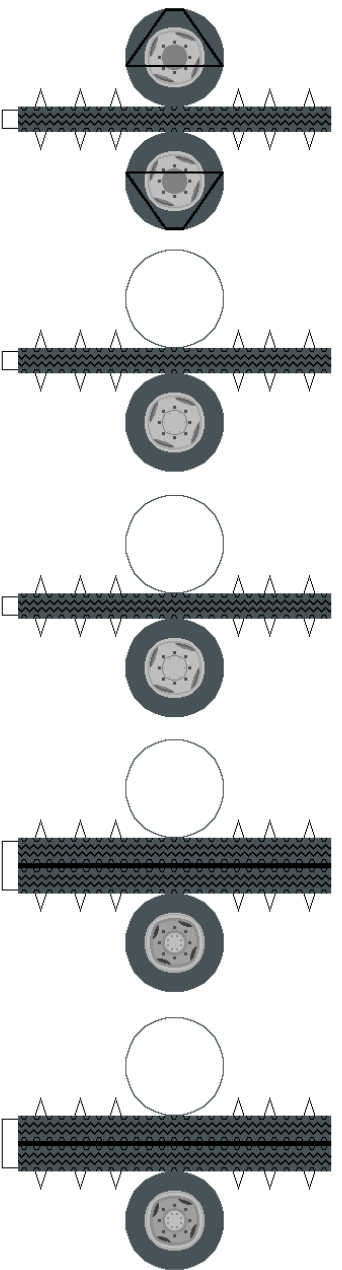

Olvasd el a ragasztási tanácsokat is!

A segédvázakat ragaszd, az alvázon található,
piros vonalakra!

