

7
Avondfélt a kijelölthelyre ragaszd!

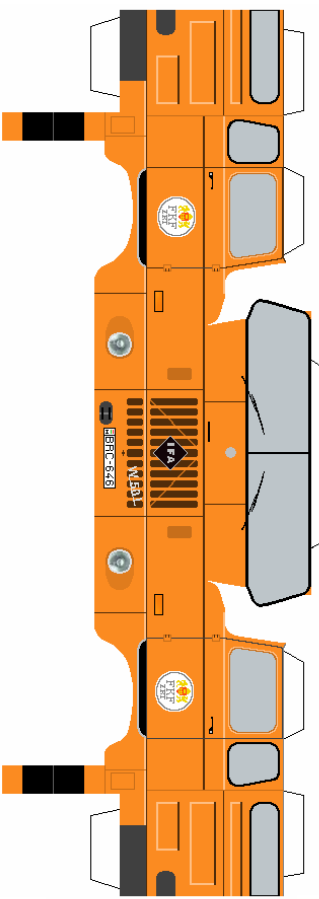

4
podkerék

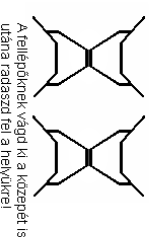
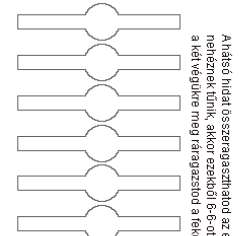
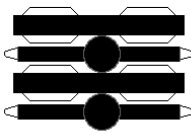
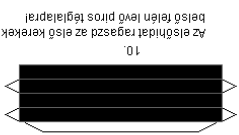
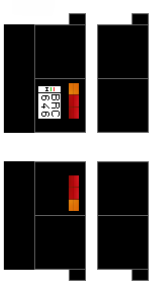
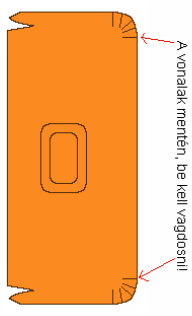
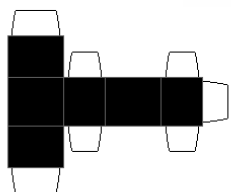
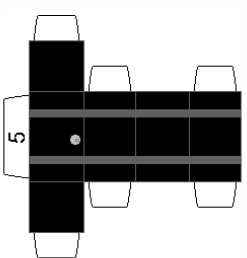
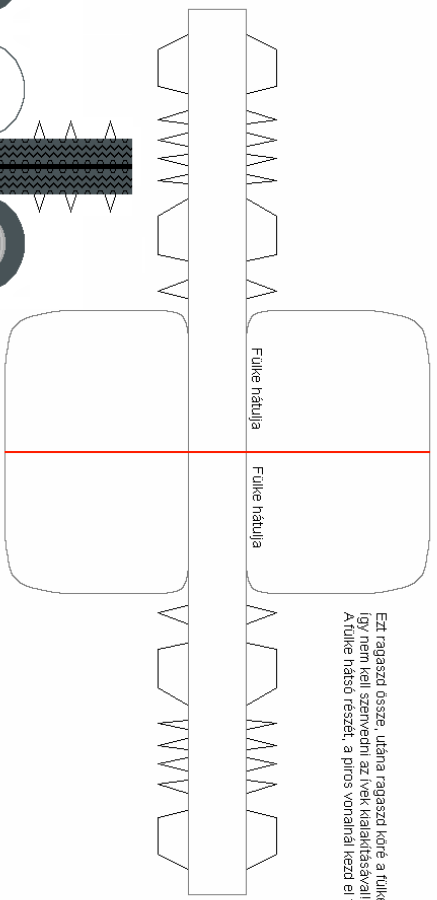
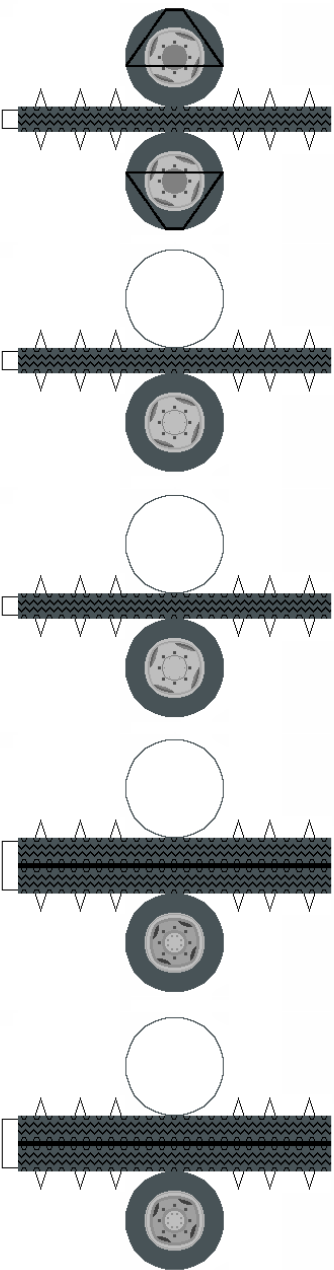

Ezt ragaszd össze, utána ragaszd köré a fülkét, így nem kell szerveneti az ívek kialakításával. A fülke hátsó részét, a piros vonallal kezd el felragasztani!

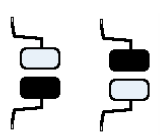

Olvasd el a ragasztási tanácsokat is!

A hosszú segédvázakat elől a piros vonalhoz, hátul az alváz végéhez igazítsd!
A rövidebbeket, hosszianyban ragaszd az alváz szélére!

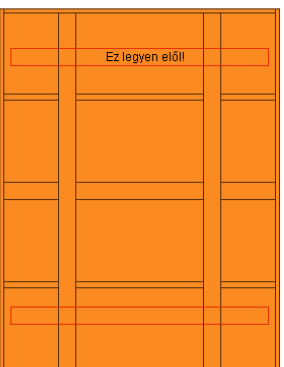
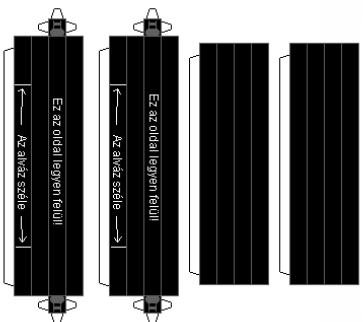

Ezt ragaszd a billenő plató aljára. A piros vonalás részt ragaszd a keresztben lévő, hosszabb segédvázakkal!

